



STORM DOORS

STORM DOORS

STORM DOORS

Every ProVia® storm door is individually customized to the highest standards in the residential market for homeowners who appreciate impeccable, uncompromising quality.

PAINT FINISHING SYSTEM

Our paint process is computer controlled, ensuring professional quality every time. Paint is electrostatically applied with a vertical hydraulic reciprocator using a turbo disc that atomizes the paint particles for better coverage of contoured extrusions.

STORM DOOR PAINT COLORS

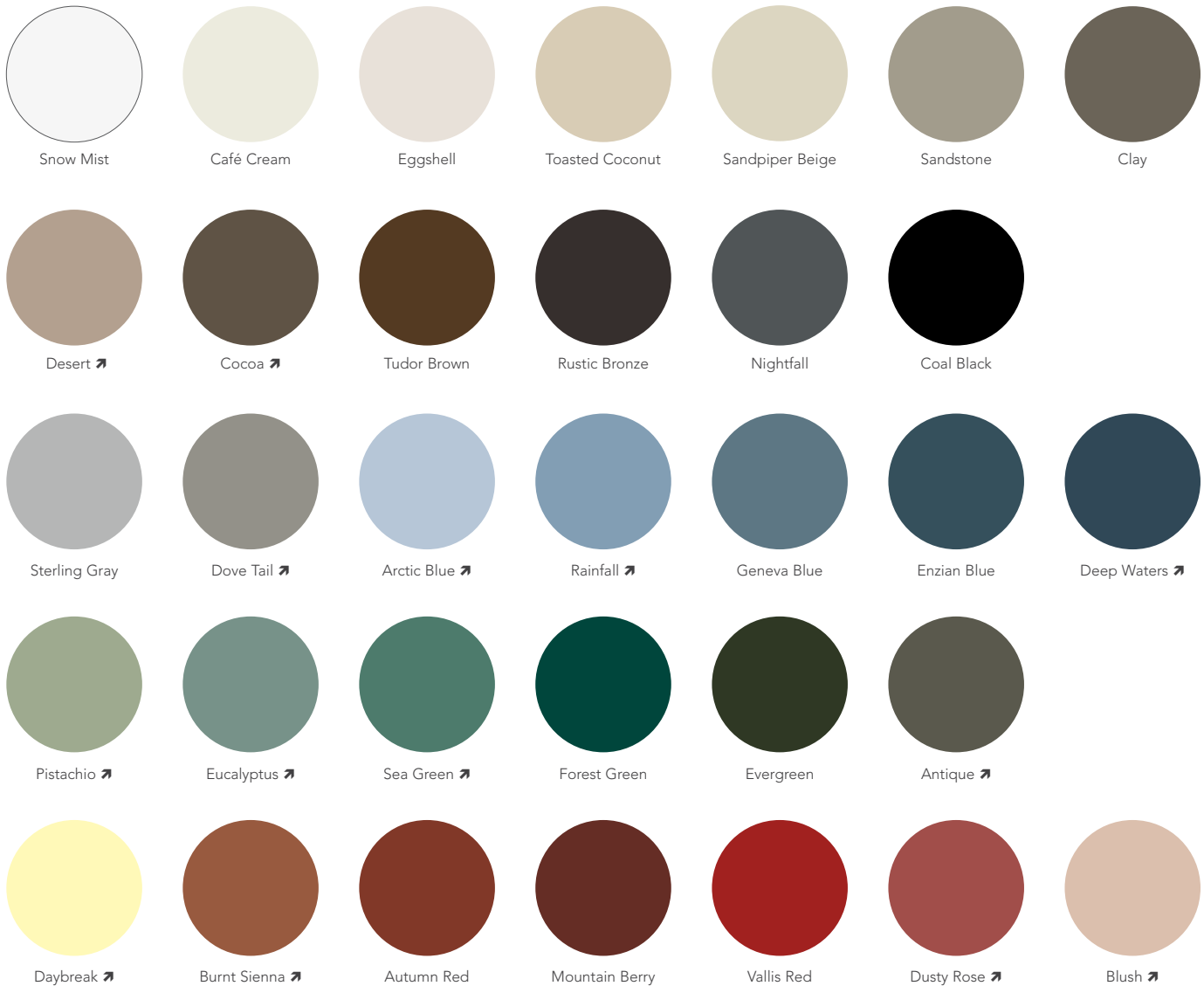

↗ Denotes Trending Color

Always refer to our color selector for accurate color representation.

LIFETIME FINISH WARRANTY

For all Storm Doors



Smooth function is essential. That's why we include a **quality door closer** in every storm door package. Varies by model.

Our air release system features a continuous closing action without the delayed rebound action of previous generation closers.



You'll appreciate the finished look of our **color matched aluminum installation screw covers**.

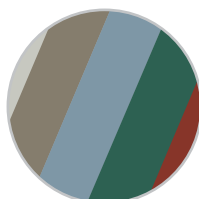

Durable, oven-baked polyester finishes are backed by a Lifetime Warranty for lasting beauty and low maintenance.

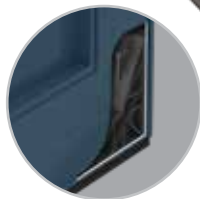

Corrosion-proof corner gussets enhance the structural integrity of the door.



Extruded aluminum frame adds beauty to your door by virtue of the rounded cove molding along the glass edge of the extrusion.

All our storm doors are constructed with **tempered safety glass**.



Non-operable sashes are secured by our **color matched polycarbonate clips** or an **internal sash lock system**. Varies by model.

Each door features **quality hardware** that adds beauty and functionality to your new storm door. Varies by model.



Our **bottom expander with sweep** allows for a beautiful custom-fit to any entry. Varies by model.

STORM DOOR FEATURES

TOP STORM DOOR FEATURES

- ✓ Custom sizing availability
- ✓ Can be keyed to match entry door
- ✓ Optional double mortise hardware
- ✓ Custom door configuration ability
- ✓ Ability to match paint color to your ProVia® entry door

SASH/SCREEN CONFIGURATIONS

INVENT™ RETRACTABLE SCREENS:

- The screens are housed inside the door frame and affixed to the sash rails. Moving the sashes up and down will reveal the screen for ventilation.
- Only available on **Spectrum™** storm doors.

DURAGUARD™ SCREENS:

- This specialty storm door features a stainless steel screen that cannot be removed from the frame.
- In select models, a removable sash can be added to fit over the fixed screen when ventilation is not necessary.

STATIONARY SASH/SCREEN:

- Either a sash or screen may be ordered to be used interchangeably.
- Sash clips or internal cam locks are built into the storm door to lock the sash or screen in place and keep them secure (see *sash clip/internal cam lock call-out on page 2*).
- Available in all **Decorator™** models and select **Deluxe™** and **Superview™** models.

SELF-STORING SASH/SCREEN:

- The sashes and screen operate on separate tracks in the storm door to allow ventilation, while eliminating the need for seasonal removal and storage.
- **Deluxe** self-storing models include a full screen and **Superview** self-storing models include a bottom screen.

CONSTRUCTION	Spectrum	Decorator	Deluxe	DuraGuard	Superview
1 InVent retractable screen system	●				
2 Outside corners are secured to corrosion-proof gussets, for structural integrity	●	●	●	●	●
3 Color matched aluminum installation screw covers enhance the appearance of your door	●	●	●	●	●
4 Triple bottom sweep eliminates drafts	●	●	●	●	●
5 The sculptured frame adds durability	1¼" x 4½"	1¼" x 4"	1¼" x 3½"	1¼" x 3½"	1¼" x 2½"
6 Multi-hollow construction provides greater strength and security than standard storm doors	●	●	●	●	
7 The reinforced aluminum kick panel adds durability	●		●	●	
8 The aluminum kick panel resists rust and adds strength	●		●	●	●
9 Corner keys provide added support to the inside of the door frame	●	●	●	●	●
10 Aluminum wall thickness up to 20% thicker than industry standard	●	●	●	●	
11 The .023 gauge stainless steel screen offers extra security and protection (12 x 12 mesh)				●	
12 Non-operable sash/screen secured by internal lock system or color matched polycarbonate clips		Internal Lock	Clips		Clips
13 Standard insulated frame core to help reduce air movement	Optional	●	Optional	Optional	
14 Screen included	●	Optional	●	●	●

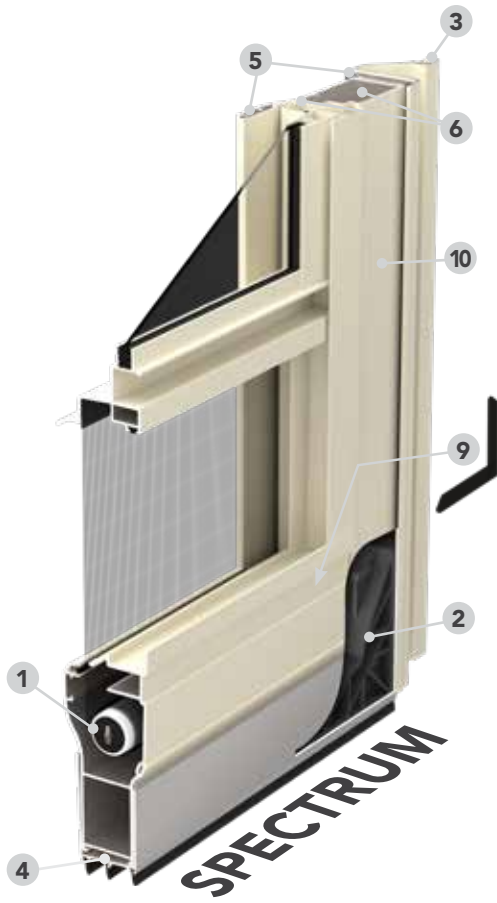

Internal Sash Lock System

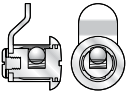

This spring-loaded, flush mounted lock secures the glass, virtually eliminating rattles and air leaks.

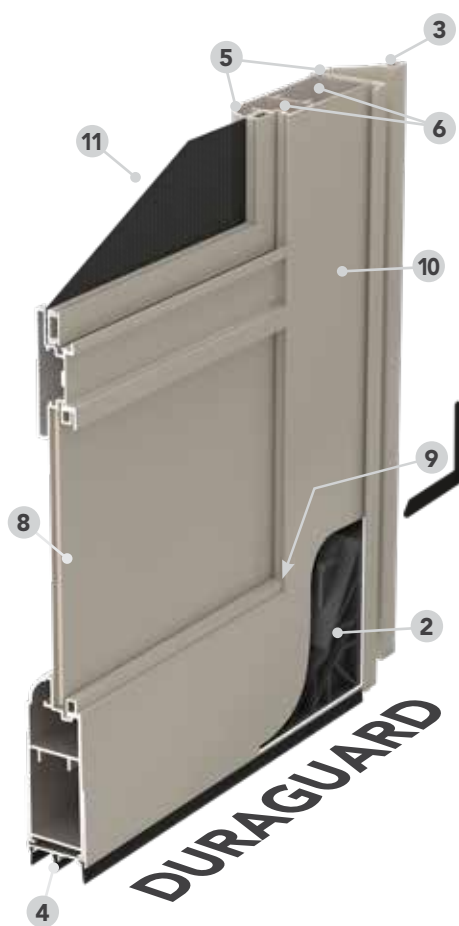
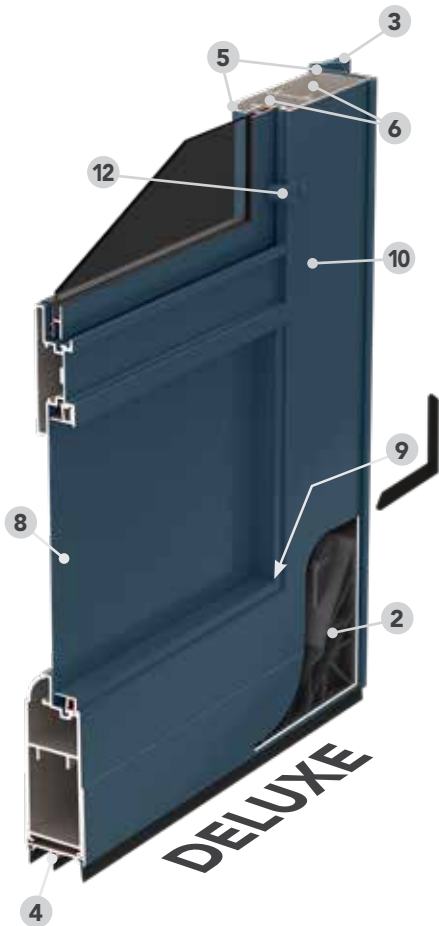

SPECTRUM™ STORM DOORS

Spectrum storm doors bring you smooth functionality, beauty and durability. Our exclusive top and bottom InVent™ retractable screen system allows you more venting options than ever.

SPECTRUM STORM DOORS INCLUDE:

- Two InVent retractable screens
- Triple seal bottom sweep
- 1¼" x 4¾" wide sculptured frame

LIFETIME LIMITED WARRANTY

Includes Glass Breakage

STANDARD HARDWARE & ACCESSORIES

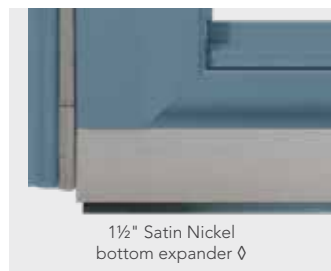
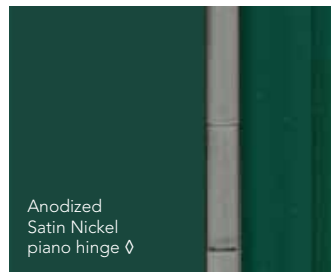

Spectrum 291SH Full View Storm Door in Coal Black featuring Sierra Multi-Point Mortise hardware in Black

AVAILABLE STYLES:



295 Full View Double Prairie with Beveled Glass



298-VG Three-Quarter View with Beveled Glass



291 Full View (Art Glass available)





298 Three-Quarter View (Art Glass available)



279-C Colonial Half-Lite ‡

SASH ARROWS

-  **Double Arrows:**
Both sashes are operable
-  **Single Arrow:**
Single-hung, one sash is operable

Applies to pages 6, 10, 12, & 13



279 Flush Half-Lite ‡



292 Provincial Half-Lite ‡



293 Crossbuck Half-Lite ‡



291SH Full View (Only one InVent top screen and fixed bottom sash)



298SH Three-Quarter View (Only one InVent top screen and fixed bottom sash)



274-CSH Colonial Half-Lite (Only one InVent top screen and fixed bottom sash) * ‡



274SH Half-Lite (Only one InVent top screen and fixed bottom sash) * ‡



298-AME Americana

ART GLASS

See entryLINK for style availability.

Acrylic is required (instead of tempered glass) for custom size storm doors where the sash size is greater than 20 square feet or the sash weigh is greater than 36 pounds. entryLINK will automatically change the glass selection to acrylic based on these limits.

* When top sash opens, it passes in front of kick panel.

‡ Available in 8' height

Note: The bottom expander on the Spectrum storm door is 2½" on the exterior and 1⅜" on the interior to accommodate the frame profile.



For French Storm Door information refer to entryLINK.

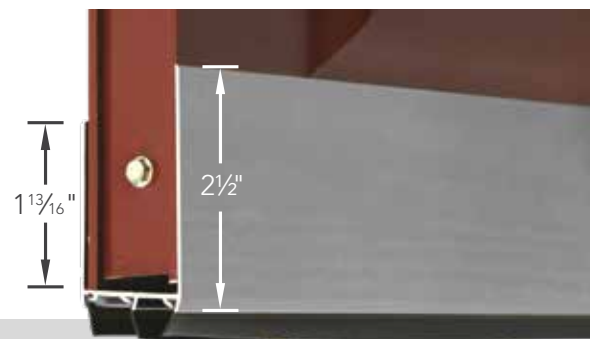

DECORATOR™ STORM DOORS

Decorator storm doors provide a stylish, fresh look to accent your entry door. Select one of the distinct styles from our Decorator storm doors.



Decorator 595 Full View Storm Door in Snow Mist with Double Prairie Beveled Glass featuring Windsor hardware in Bright Brass

DECORATOR STORM DOORS INCLUDE:

- Triple seal bottom sweep
- 1¼" x 4" wide sculptured frame

LIFETIME LIMITED WARRANTY
Includes Glass Breakage

STANDARD HARDWARE & ACCESSORIES

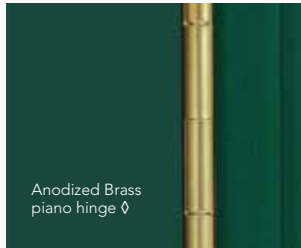

AVAILABLE STYLES:



591 Full View Archway with Beveled Glass



595 Full View Double Prairie with Beveled Glass



590 Full View ‡



590-VIN Vintage ◊ ‡

ART GLASS
See entryLINK for style availability.

Acrylic is required (instead of tempered glass) for custom size storm doors where the sash size is greater than 20 square feet or the sash weigh is greater than 36 pounds. entryLINK will automatically change the glass selection to acrylic based on these limits.

Optional full screen with horizontal stabilizer bar available for all Decorator doors.

◊ Satin Nickel hardware and anodized Satin Nickel piano hinge are standard on Decorator storm doors with art glass.

‡ Available in 8' height



For French Storm Door information refer to entryLINK.

This spring-loaded, flush mounted lock secures the glass, virtually eliminating rattles and air leaks. Only available in Zinc finish.



DELUXE™ STORM DOORS

Deluxe storm doors are the answer whether you're looking for additional light, ventilation or protection from the elements. You'll find the exact style you're looking for in our Deluxe storm doors.

DELUXE STORM DOORS INCLUDE:

- Triple seal bottom sweep
- 1¼" x 3⅝" wide sculptured frame
- BetterVue® fiberglass screen

LIFETIME LIMITED WARRANTY

Includes Glass Breakage

STANDARD HARDWARE & ACCESSORIES

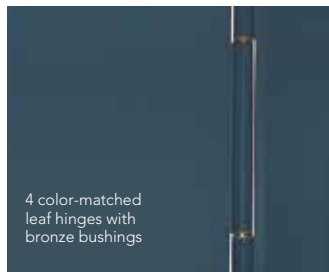
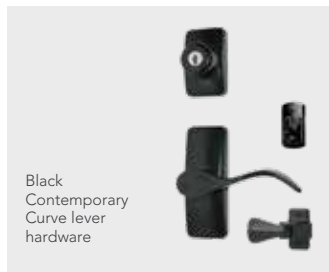

Deluxe 397 Full View Storm Door in Rustic Bronze featuring Sierra Multi-Point Mortise hardware in Aged Bronze

AVAILABLE STYLES:



385 Full View Double Prairie with Beveled Glass (Includes screen*)



382 Full View with Beveled Glass (Includes screen*)



397 Full View (Includes screen*)



391 Full View Divided Lite (Includes top screen) ‡



396-V One-Lite with fixed .023 gauge stainless steel screen ventilated bottom & removable sash (Includes top screen*) ‡ (Art Glass available)



396 One-Lite (Includes screen*) (Art Glass available) ‡



399-M Modern Self-Storing (Includes full screen) ‡



399 Self-Storing (Includes full screen*) ‡



398-M Modern Hi-Lite (Includes top screen) ‡



398 Hi-Lite (Includes top screen) ‡



389-M Modern Self-Storing (Includes full screen*) ‡

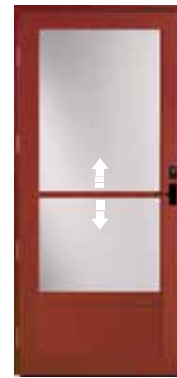

389 Self-Storing (Includes full screen*) ‡



379-C Colonial Self-Storing (Includes full screen) ‡



379 Self-Storing (Includes full screen) ‡



392 Provincial Self-Storing (Includes full screen) ‡



394 Provincial (Includes screen) ‡



393 Crossback Self-Storing (Includes full screen) ‡



395 Crossback (Includes screen) ‡



374-C Colonial Half-Lite (Includes screen) ‡



374 Flush Half-Lite (Includes screen) ‡



397-VIN Vintage

ART GLASS
See entryLINK for style availability.



For French Storm Door information refer to entryLINK.

* Full and One-Lite screens have horizontal stabilizer bar.

‡ Available in 8' height

Acrylic is required (instead of tempered glass) for custom size storm doors where the sash size is greater than 20 square feet or the sash weigh is greater than 36 pounds. entryLINK will automatically change the glass selection to acrylic based on these limits.

DURAGUARD™ STORM DOORS

DuraGuard storm doors are exactly what you need if you're concerned about keeping your small children and pets safely inside. Select one of our doors with heavy-duty, non-removable stainless steel screening.



DuraGuard 097 Screen Door in Nightfall featuring Contemporary Curve hardware in Black

.023 stainless steel black screen is standard. Also available in white.

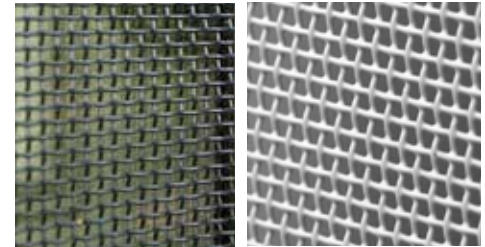

Note: White screen can appear to have different levels of transparency depending on the lighting and background.

DURAGUARD STORM DOORS INCLUDE:

- Non-removable .023 stainless steel screen (only available on DuraGuard models)
- Triple seal bottom sweep
- 1¼" x 3⅝" wide sculptured frame

LIFETIME LIMITED WARRANTY

Includes Glass Breakage

STANDARD HARDWARE & ACCESSORIES



Black Contemporary Curve hardware

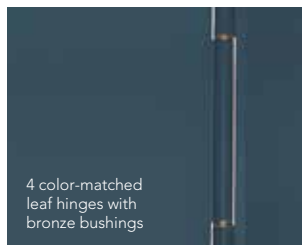

4 color-matched leaf hinges with bronze bushings



Color matched bottom expander



Heavy-duty color-matched closers



097 Screen Door ‡
097-G with removable
glass insert

096 Screen Door ‡
096-G with removable
glass insert ‡

096-GV With ventilated
bottom and removable
top and bottom sashes ‡

099 Self-Storing
Sash & Screen

099-M
Modern Self-Storing
Sash & Screen

089 Self-Storing
Sash & Screen



089-M
Modern Self-Storing
Sash & Screen

074 Flush Half Lite
(Removable sash) ‡

074-C
Colonial Half Lite
(Removable sash) ‡

094 Provincial Half Lite
(Removable sash) ‡

095 Crossbuck Half Lite
(Removable sash) ‡

079 Self-Storing
‡



079-C Colonial
Self-Storing ‡

092 Provincial
Self-Storing ‡

093 Crossbuck
Self-Storing ‡

Acrylic is required (instead of tempered glass) for custom size storm doors where the sash size is greater than 20 square feet or the sash weigh is greater than 36 pounds. entryLINK will automatically change the glass selection to acrylic based on these limits.

‡ Available in 8' height



For French Storm Door information refer to entryLINK.

SUPERVIEW™ STORM DOORS

Superview storm doors offer a selection of doors constructed for style and value in one complete package.



STANDARD HARDWARE & ACCESSORIES

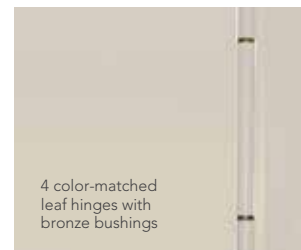

SUPERVIEW STORM DOORS INCLUDE:

- Triple seal bottom sweep
- 1¼" x 2⅝" wide sculptured frame
- BetterVue® fiberglass screen

LIFETIME LIMITED WARRANTY

Includes Glass Breakage

Superview storm doors are available in the following colors:

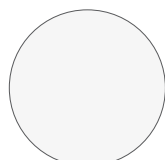

Snow Mist



Café Cream

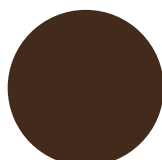

Tudor Brown

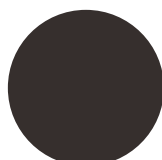

Rustic Bronze

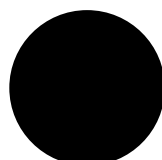

Coal Black

Always refer to our color selector for accurate color representation.



897 Full View
(Includes screen*)



896 One-Lite
(Includes screen*)



898 Hi-Lite
(Includes top screen)



899 Self-Storing
(Includes bottom screen)



895 Crossback
(Includes screen)

* Full and One-Lite screens have horizontal stabilizer bar



For French Storm Door information refer to entryLINK.

MULTI-POINT MORTISE HARDWARE

Mortise hardware adds a special touch to your storm door with a solid brass handleset to suit your style. Our Multi-Point Mortise hardware conveniently allows you to use the same key for your storm door and your ProVia® entry door.

CAMDEN (SOLID BRASS MORTISE)



SIERRA (SOLID BRASS MORTISE)

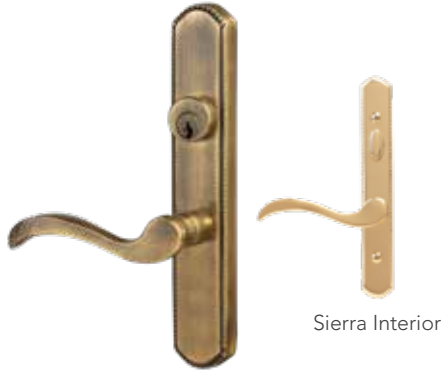

Camden Mortise hardware in Black

VENICE (SOLID BRASS MORTISE)



Mortise hardware features a multi-point locking system for added strength and security not found on typical consumer-grade storm door hardware.

Requires a factory handleset prep and is not available on expander doors and Superview storm doors.

AVAILABLE FINISHES

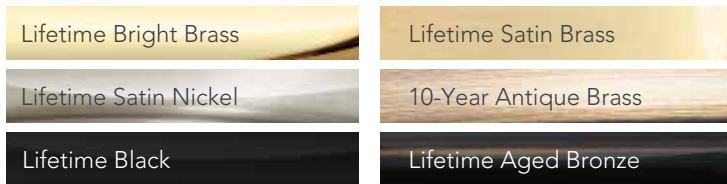

MULTI-POINT AVAILABILITY

FINISHES	FINISHES						SERIES					
	Exterior Handle Styles	LIFETIME Bright Brass	LIFETIME Satin Nickel	LIFETIME Aged Bronze	LIFETIME Black	LIFETIME Satin Brass	10-Year Finish Antique Brass	Spectrum™	Decorator™	Deluxe™	DuraGuard™	Superview™
Sierra	●	●	●	●	●	●	●	■	■	■	■	
Venice	●	●	●	●	●	●	●	■	■	■	■	
Camden	●	●	●	●	●	●	●	Standard*	■	■	■	

● Interior handle finish matches exterior handle

■ Available as an option

SINGLE-POINT MORTISE HARDWARE

WESTGATE



Westgate Interior

AVAILABLE FINISHES

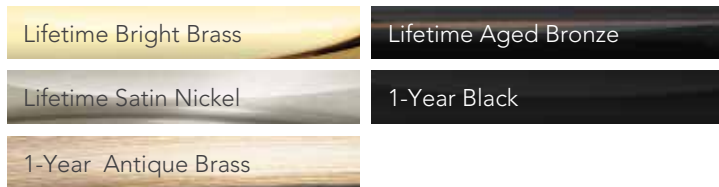

Optional Single-Point Mortise hardware, offering enhanced security, durability and style over standard surface-mounted hardware.



CAMBRIDGE



Cambridge Interior

AVAILABLE FINISHES

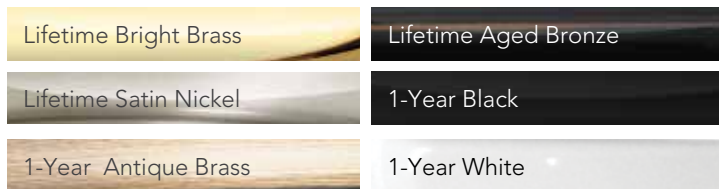

Not available to be keyed to entry door.

Requires a factory handleset prep and is not available on expander doors and Superview storm doors.

SINGLE-POINT AVAILABILITY

FINISHES	FINISHES						SERIES					
	Exterior Handle Styles	LIFETIME Bright Brass	LIFETIME Satin Nickel	LIFETIME Aged Bronze	1-Year Antique Brass	1-Year White	1-Year Black	Spectrum™	Decorator™	Deluxe™	DuraGuard™	Superview™
Cambridge	●	●	●	●	●	●	■	■	■	■		
Westgate	●	●	●	●		●	■	■	■	■		

● Interior handle finish matches exterior handle

■ Available as an option

TRADITIONAL HARDWARE

With both elegance and durability, our hardware makes the right first impression.

EXTERIOR HANDLES

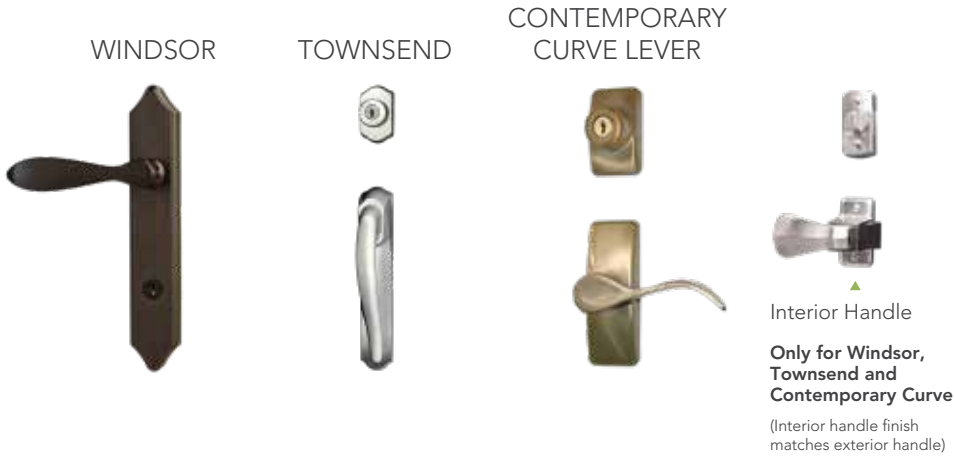

AVAILABLE FINISHES

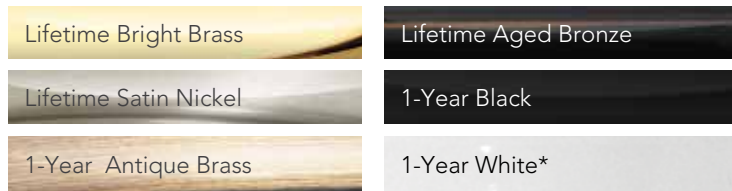

*Only available in Contemporary Curve Lever



Contemporary Curve Lever in Black

PUSH BUTTON



201

PULL HANDLE



182

Interior Handle



AVAILABLE FINISHES

Push Button/Pull Handle

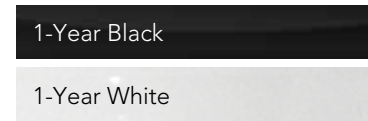

TRADITIONAL HARDWARE AVAILABILITY

FINISHES	LIFETIME						SERIES				
	Bright Brass	Satin Nickel	Aged Bronze	1-Year Antique Brass	1-Year White	1-Year Black	Spectrum™	Decorator™	Deluxe™	DuraGuard™	Superview™
Windsor	●	●	●	●	●	●	■	Standard	■	■	■*
Townsend	●	●	●	●	●	●	■	■	■	■	■*
Contemporary Curve	●	●	●	●	●	●	■	■	Standard†	Standard†	■*
Push Button (DH201 & DH202)						●			■	■	■*
Push Button (DH192)											■
Pull Handle					●	●					Standard†

- Interior handle finish matches exterior handle
- Available as an option
- † Standard color is black
- * Not available on Superview Model 899

ACCESSORIES & GLASS OPTIONS

All pet doors are factory installed and only available on storm doors with reinforced kickpanels.



RANGER® PET DOOR

Engineered from the best raw materials for a rugged, long-lasting door.

- **Cellular PVC Frame** – Strong, weatherproof, and mold-resistant, and 3,000X more insulating than metal frames.
- **Rugged Flap System** – The insulated flap system is made from premium materials for maximum energy-efficiency, pet safety, and durability. The flap has an insulating SBR rubber core, protected with marine-grade canvas on each side.
- **Locking Security Panel** – All door-mounted RANGER dog doors include a locking security panel.
- **DoubleMag™ Technology** for an airtight seal that keeps extreme weather outside.

DOOR SIZE	DIMENSIONS	PET WEIGHT
Small	6" x 10"	up to 20 lbs.
Medium	9" x 13"	up to 40 lbs.
Large	11" x 17"	up to 100 lbs.



COLORS

- Clear flap with white interior/exterior frame and a white locking panel on the interior (pictured to the left).
- Grey flap with black interior/exterior frame and a black locking panel on the interior.

See [entryLink](#) for details



FREEDOM® PET DOOR

- Solid aluminum construction with locking panel
- Soft single flap for tight weather seal
- White mitered aluminum frame
- Only available with heavy-duty closers.

Pet Door N/A with dual closers

DOOR SIZE	DIMENSIONS	PET WEIGHT
Medium	8¼" x 12¼"	up to 40 lbs.
Large	10¼" x 16¼"	up to 100 lbs.
X-Large	13¾" x 23¾"	up to 220 lbs.



MAGAZINE & MAIL SLOT

Magazine and mail slots are available on storm door models: 074, 079, 279, 374 and 379 with reinforced, flush kickpanels.



Lifetime Bright Brass



Lifetime Aged Bronze



Lifetime Satin Nickel

PIANO HINGE & BOTTOM EXPANDER



Anodized Brass



Satin Nickel



Aged Bronze

#079 Self-Storing with mail slot option



EASY-SET CLOSER

Our **air release system** features a continuous closing action without the delayed rebound action of previous generation closers. Just a slight push on the cap and it will stay open. Push door open further and it releases. Color matched to door.

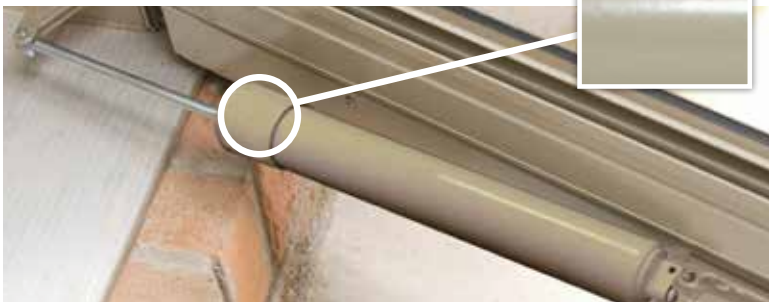

PRIVACY GLASS

Choose from Obscure Pebble or Gluechip glass if you need light to filter in, yet want to maintain privacy.



GLUECHIP



OBSCURE PEBBLE



Bronze



Green



Gray



Blue

TINTED GLASS

Tinted glass can help reduce UV transmittance, solar heat gain and glare. Each tinted glass option provides a room a whole new look, providing its own unique set of benefits. Be sure to choose the right one for your home.



“To serve, by caring for details in ways others won’t.” It’s not just our mission, but a way of letting our light shine every day at ProVia®. We continually strive to put these words into action by providing unmatched quality and service. The P-icon symbolizes each employee’s commitment to devoting the utmost care, pride and quality into each building product we manufacture...it’s The Professional Way.



At ProVia, we manufacture energy efficient products and exercise corporate environmental stewardship by recycling, reducing pollution emissions and much more. In fact, our company has received repeated awards from the Environmental Protection Agency such as Partner of the Year - Sustained Excellence for Door and Window Manufacturing.



DOORS | WINDOWS
SIDING | STONE | ROOFING
provia.com

© 2025 ProVia
P-MK-00085-25 | 9/24

Distributed by: